

EGO™

POWER BEYOND BELIEF™

**Optimum
power and
performance**

EGO 56V ARC Lithium™ battery technology explained.



Welcome to everything you need to know about **EGO** battery technology



The power to beat petrol...



The outdoor power tool market is experiencing the biggest revolution since petrol-powered mowers arrived on the scene over 100 years ago. Fossil fuels are being replaced by cleaner, greener energy sources across the world.

Thanks to advances in battery technology, it is now possible to achieve petrol-matching power – without the noise, fuss or fumes. That makes EGO battery powered equipment not just a viable alternative, but the preferred solution for a wide range of outdoor applications. And performance is only one reason why battery power makes sense.

Ditching petrol is also the best way to stay safe, healthy and up-to-date with increasing legislation – from tackling hand-arm vibration to limiting noise and reducing emissions.

However, not all batteries are created equal

Choosing the right battery is crucial, but the technology can be complex and confusing. Fortunately, as the specialists in cordless technology, EGO have got the answers. In this Q&A, we explain everything users need to make an informed choice and ensure they get the most out of their equipment.

ZERO

EMISSION

EGO 56V ARC Lithium™ technology. Why is there **nothing else like it?**

EGO's unique 56V ARC Lithium™ battery technology delivers unmatched versatility and performance, giving you the dependable power you need to keep working hard until the job's done. Here's what sets EGO batteries apart:

Industry's most versatile battery solution

Our team of experts have completely revolutionised battery technology to deliver the optimum power and performance across the full range of battery-powered outdoor power equipment.

The 56V ARC Lithium™ battery is a marvel of engineering that provides the right level of power for every task, whilst innovatively managing heat - mechanically, chemically and electrically. We have 25 years' experience with battery technology and the majority of components are built in-house. For those components sourced from third parties such as battery cells, we use only the most reputable brands such as Sanyo and Samsung.

All the power of petrol. Minus the petrol

Powered by our unique 56V ARC Lithium™ battery, the EGO Power+ system delivers petrol-matching power but without any of the downsides. It's simpler, cleaner, quieter and with less vibration is more comfortable to use. Impressive run times and fast recharge offer the ultimate in convenience.

With lower running and maintenance costs, switching to EGO will lead to long term savings. Plus, with zero emissions during use, you can do your bit to reduce your impact on the environment too.

Most flexible solution for outdoor garden equipment

For real flexibility, there are a range of EGO 56V ARC Lithium™ batteries to suit any task, plus - any EGO battery will fit any tool in the EGO Power+ range.

Just click in the battery and you're ready to go. And of course you don't have to pause work to go to the petrol station for fuel or worry about the logistics of storing highly flammable liquids.

The brain power behind our **battery power**

EGO's commitment to innovation is driven by a talented team of over 800 highly qualified technicians responsible for developing and delivering clean, reliable power tools for today's switched-on customers.

Working in our dedicated R&D centre, they partner with international teams to design innovative, durable and powerful tools that deliver superior performance. Our team of internationally and professionally recognised testing engineers also implement international safety authorisations and help define global safety and quality standards.

Switch today

The EGO Power+ system outperforms petrol without any of the downsides. It's simpler, cleaner, quieter – and with less vibrations, more comfortable to use. Lower running and maintenance costs means switching to EGO Power+ leads to long-term savings too. Its cutting-edge battery technology delivers optimum power and performance for every tool and for every job. Plus, with zero emissions during use, it reduces your impact on the environment.



Why change from petrol to EGO Power+?



SUPERIOR BATTERY TECHNOLOGY

Our industry-leading 56V ARC Lithium™ batteries deliver intelligent, balanced, petrol matching power for all EGO tools



BETTER FOR THE ENVIRONMENT

With zero emissions during use, our 56V ARC Lithium™ battery gives petrol-matching power but without the fuss and fumes



BETTER FOR YOUR HEALTH

EGO Power+ tools always operate at lower noise and vibration levels than traditional petrol-powered tools



EASY SET-UP AND STARTING

No filling up with fuel; with EGO Power+ just click in the battery and get to work



NO PETROL TO STORE

No more dangerous fuel in storage, no more fumes, make more space available for other things



POWERS 100+ TOOLS

EGO 56V ARC Lithium™ batteries work with all EGO Power+ tools,** offering ultimate flexibility and efficiency to complete any job of any size



LOWER RUNNING COSTS

The cost of running an EGO Power+ product for a month is around the same as using a 2 stroke product for a day*



FOLD FLAT, EASY STORE DESIGN

Unlike large, heavy petrol mowers, the EGO Power+ fold-flat design makes storage, cleaning and transportation simple



SAVE TIME

No more trips to the petrol station. EGO's rapid charger refuels our intelligent batteries in as little as 30 minutes

*Based on average daily use of 3 litres of post mix fuel per day.

**For portable handheld batteries.

EGO Robotic Mowers and 12V Shrub Shears are not compatible with ARC Lithium™ 56V battery system.

CONTENTS

BATTERY BASICS

How is the power of a battery calculated?	10
What are voltage, current, capacity and resistance?	11
How can I visualise the relationship between voltage and current?	12
What does the information on a battery label mean?	13
What's the difference between series circuits and parallel circuits?	14
What does 1P, 2P, 3P, 4P etc mean?	15
What's the ideal number of cells?	16
How does EGO ensure the highest battery cell quality?	17
How does EGO ensure the highest battery performance?	18

MANAGING HEAT TO MAXIMISE PERFORMANCE

How does my choice of battery affect power and run time?	20
How does the EGO Power+ 56V ARC Lithium battery manage heat?	24

WHY EGO 56V?

EGO 56V is the ultimate in versatile power	31
Should I use a smaller voltage than 56V for less demanding tasks?	33

CHOOSING THE RIGHT BATTERY FOR THE JOB

Which battery should I use?	37
Are EGO batteries compatible with every device?	39
Are some tools designed to use more than one EGO battery?	41
Are EGO batteries effective when used with EGO professional tools?	42
EGO vs competitors	44

EGO VS THE COMPETITION

What makes EGO the best?	46
Do EGO batteries have more usable power than competitors?	48
Are there any other battery technologies out there?	50

CHARGING

What are the pros and cons of rapid chargers?	51
How many recharge cycles can be expected?	52
How many batteries can be charged from a single charger?	53
How does this compare to the competition?	55
Can batteries be charged remotely on site?	56
Can the charging and status of EGO batteries be controlled remotely?	57
How cost effective and efficient is the EGO charging system?	58

LOOKING AFTER YOUR BATTERIES

How should batteries be stored?	60
How should batteries be transported?	61
Are EGO batteries weather resistant?	62
What should be done with wet batteries?	63
What is the shelf life of a typical battery?	64
What is the warranty period and what should I do if my battery is faulty?	65
How should EGO batteries be recycled?	66

WHAT DO YOU GET WITH AN EGO BATTERY?

69

BATTERY BASICS

How is the power of a battery calculated?	10
What are voltage, current, charge and resistance?	11
How can I visualise the relationship between voltage and current?	12
What does the information on a battery label mean?	13
What's the difference between series circuits and parallel circuits?	14
What does 1P, 2P, 3P etc mean?	15
What's the ideal number of cells?	16
How does EGO ensure the highest battery cell quality?	17
How does EGO ensure the highest battery performance?	18

How is the power of a battery calculated?

A battery must be able to **generate power consistently over a given period**. Power is measured in Watts (W) and calculated using the equation shown below. Watt hours (Wh) define how long this power can be delivered.

It's the relationship between voltage and current that counts. A big voltage doesn't necessarily mean big power – there also has to be enough current (and vice versa). In the instance of battery powered technology the current (A) depends on the cell types being used, the condition and quality of the cells and the control system put in place to manage them.

$$\begin{array}{ccccc} \text{VOLTAGE} & \times & \text{CURRENT} & = & \text{POWER} \\ (V) & & (A) & & (W) \end{array}$$

To work out **how long the power can be delivered**, the following equation can be used:

$$\begin{array}{ccccc} \text{VOLTAGE} & \times & \text{CAPACITY} & = & \text{ENERGY} \\ (V) & & (Ah) & & (Wh) \end{array}$$



What are **voltage, current, capacity and resistance**?



VOLTAGE (V)

Voltage is the **electric potential difference between two points**. The bigger the difference, the more potential to transfer energy.



CURRENT (A)

Current is the **amount of electrons that pass through a point in a circuit in one second**. Current is measured in amps (A). An amp hour (Ah) is the amount of electrons that pass in one hour.



CAPACITY (Ah)

Capacity can be **measured in amp hours (Ah) that are delivered at a given voltage (V)**.



RESISTANCE (Ω)

Resistance **measures how a device or material reduces the electric current that flows through it**. Resistance is measured in units of ohms (Ω).

How can I visualise the relationship between voltage and current?

When considering how electricity works, it can be useful to imagine water flowing from a tank through a pipe.

Voltage - measured in Volts (V)

This is the overall water pressure.

Capacity - measured in Amp hours (Ah)

This is the amount of water. The more water is in the tank the longer pressure and flow can be delivered.

Current - measured in Amps (A)

This is the amount of water flowing through the pipe over a given period of time.

The higher the pressure, the more water flows through the pipe.

Output - measured in Watts (W)

Resistance - measured in ohms (Ω)

This is the width of the pipe. The narrower the pipe, the higher the resistance.

But the narrower the pipe, the more pressure is required to achieve the same power.

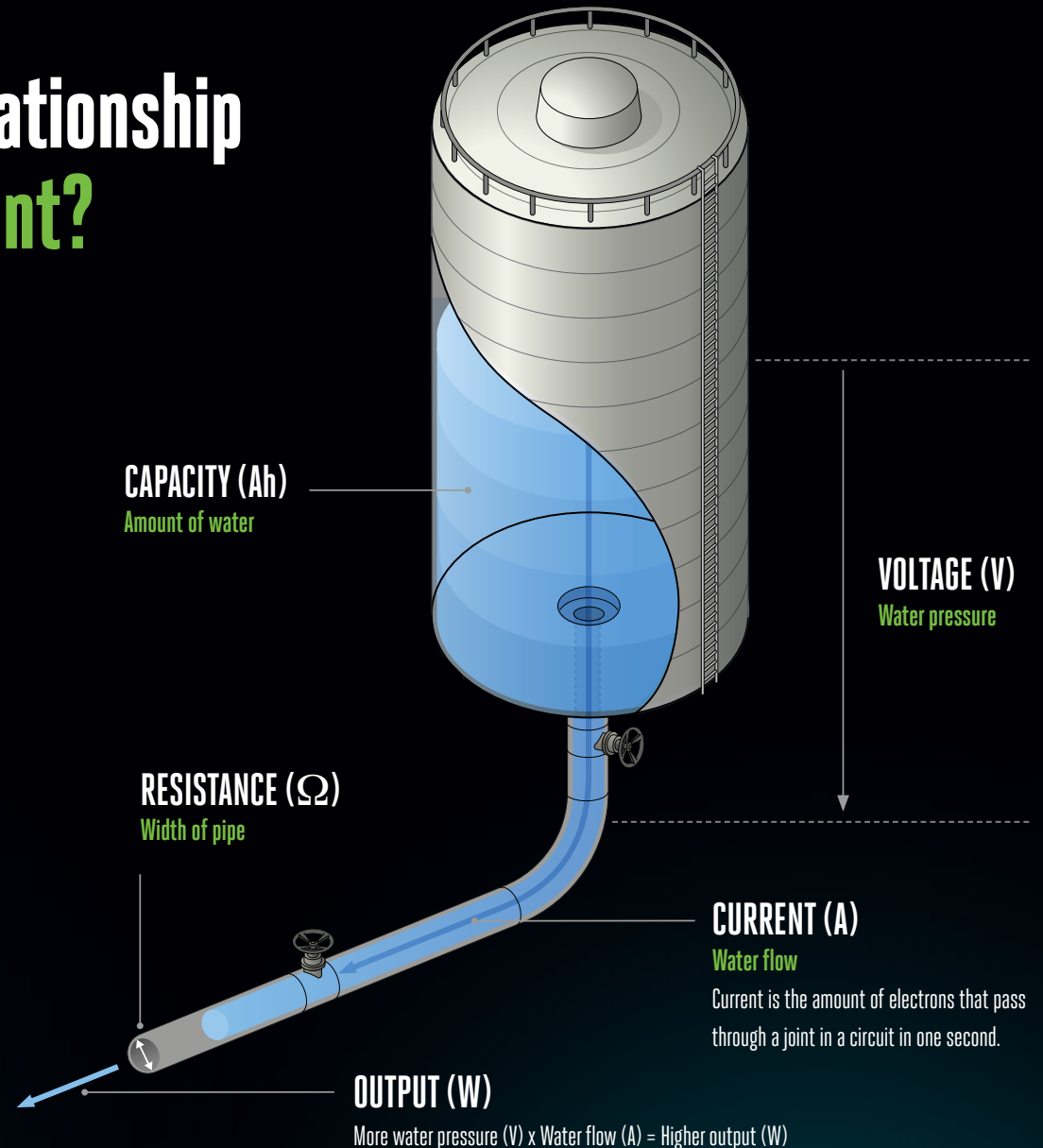

What does the information on a battery label mean?

Each battery should tell you its voltage, amp hours and total power (watt hours). Using the example opposite, the power of the battery is calculated as:

$$56V \times 2.5Ah = 140Wh$$

Voltage (V) x Capacity (Ah) = Energy (Wh)

Note:

Some battery labels use watts (W) instead of watt hours (Wh). This isn't as helpful because users don't just want to know how much power the battery generates in a given moment – they want to know how long it can deliver that power. Watt hours (Wh) is a measurement of energy over time, and an indication of run time.



What's the difference between series circuits and parallel circuits?

When battery cells are connected end-to-end in a single row they are in 'SERIES'. When more than one row is combined, the rows of battery cells are connected in 'PARALLEL'.

Arranging enough cells together in series delivers the required voltage (V). Adding an identical number of cells in parallel delivers more capacity and higher power (W)

See "What does 1P, 2P, 3P etc mean?" on page 15 for more information

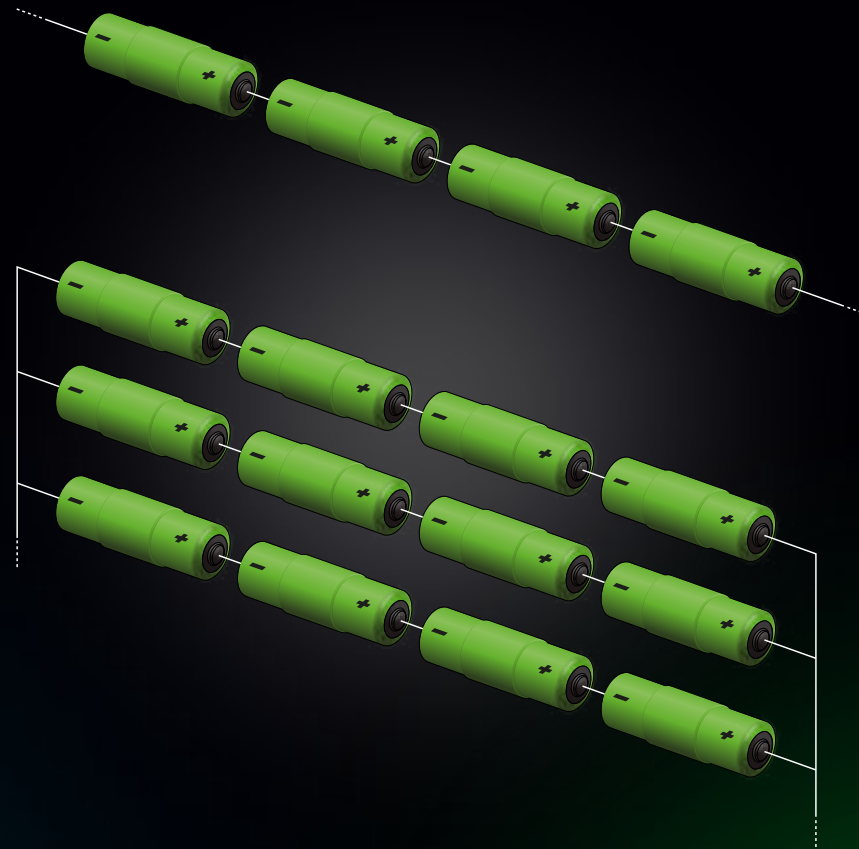

SERIES CIRCUIT

Battery cells are connected in series. This increases voltage.

PARALLEL CIRCUIT

3x rows of battery cells connected in series, connected together in parallel. This increases capacity (Ah) and power (W)

What does 1P, 2P, 3P, 4P etc mean?

More battery cells mean more power and run time. Series and parallel circuits can be combined together to pack more punch into a battery.

E60 batteries must deliver 56V for an extended period of time. To achieve this, we arrange the right number of cells in series to deliver 56V – then increase capacity (Ah) by adding more cells in parallel:

1P	Enough individual cells to reach 36V, 56V or 80V
2P	Same series of cells x2, connected in parallel, to deliver a higher capacity and more power (W)
3P	Same series of cells x3, connected in parallel, to deliver a higher capacity and more power (W)
4P	Same series of cells x4, connected in parallel, to deliver a higher capacity and more power (W)

What's the ideal number of cells?

Theoretically, we could build a battery with way more power than you'd ever need. It would also be much too big and heavy to be useful!

But we're not concerned with power for power's sake. We want to create optimum power.

EGO has developed the optimum configuration of cells to deliver the highest usable capacity in a portable hand-held battery. The 56V system allows for a wider range of application.

An 80V battery can't include as many cells as a 56V battery without becoming impractically large and heavy. 80V tools have closed battery housing which does not have room to fit a 3P battery effectively as the battery size can only grow in length, which would result in a very long battery extending beyond the tool body.

BATTERY LAYOUT	1P	2P	3P	4P
36V - 40V	10pcs	20pcs	30pcs	40pcs
50.4V - 56V	14pcs	28pcs	42pcs	56pcs
72V - 80V	20pcs	40pcs	n/a*	n/a*

THE OPTIMUM NUMBER OF CELLS TO GENERATE THE MOST POWER

*Too big and heavy for hand held use.

How does EGO ensure the **highest battery cell quality?**

Cell consistency is critical to battery performance. All individual battery cells should produce electricity as close to the same characteristics as possible.

Inconsistencies could lead to over-charging and discharging, which can impact battery lifecycle and create potential safety issues.

That's why...

We only use high quality cells from premium manufacturers

We have excellent relationships with the leading Lithium-ion cell manufacturers and continually assess the market to ensure we source the very best cells in the world. Even then, we're not satisfied...

We test and select every single cell before building a battery

We test and sort every single cell to ensure we only use the cells with the most consistent voltage.

We monitor and manage each cell during operation

Power is nothing without control. It's why the EGO Power+ 56V ARC Lithium™ battery is continuously controlled by software and microprocessors within the battery and by our tools' intelligent power management systems deliver 56V – then increase capacity (Ah) by adding more cells in parallel:

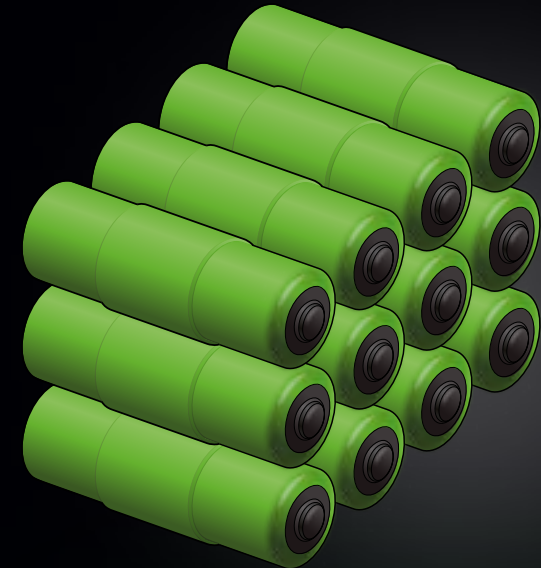

How does EGO ensure the highest battery performance?

Our specially developed Battery Management System **constantly monitors and optimises each individual cell, so you always get the very best power, performance and run time.**

Battery Management System in action

Microprocessors and software within the battery, monitor each individual cell for temperature and voltage to ensure that charging and discharging is managed in a balanced and controlled way with the other cells within the pack. This ensures each cell is performing optimally and prolongs the lifetime of the entire battery pack.

Every EGO cell is:

Sourced from premium cell manufacturers

Monitored during operation to ensure optimal function

Tested individually and selected for consistency

MANAGING HEAT TO MAXIMISE PERFORMANCE

How does my choice of battery affect power and run time 20

How does the EGO Power+ 56V ARC Lithium™ battery manage heat? 23

How does my choice of battery affect **power** and **run time**?

All the power that batteries generate comes with a trade off...



HEAT.

A battery gets hotter the longer it is used. The more power it generates, the more heat is released. Too much heat and the battery will shut down for safety. Heat also degrades cells over time, reducing battery life. That's why batteries must be cooled effectively to increase performance, run time and battery life.

The influence of battery temperature during use

Battery cells are designed to work at the temperatures shown opposite. Figures relate to cell temperature, not ambient temperature.

- Batteries can still discharge at temperatures down to -10°C , however, charging is not possible.
- If temperatures exceed 70°C , the battery management system will prevent the battery from discharging.
- The EGO snowblower can operate at temperatures of -20°C because of the insulating effect of the battery port housing.
- The unique temperature control features designed into EGO batteries keep the operating temperature of the battery cells in the sweet spot for longer. Prolonging battery run time and battery life. See pages 24-29 for further details.

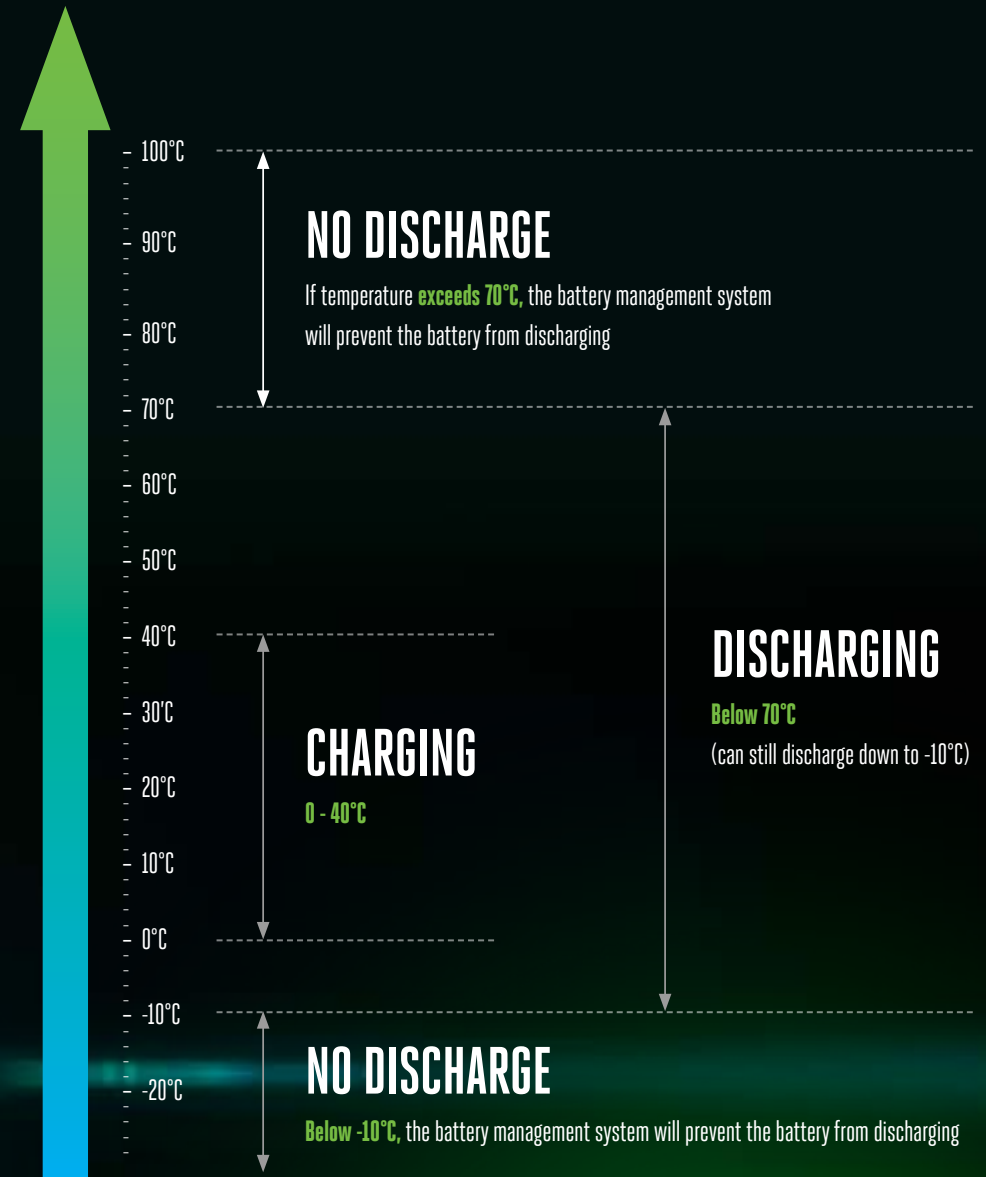

So how do we manage heat while ensuring **maximum power, run time, and battery lifetime?**

Through innovative design...



How does the EGO Power+ 56V ARC Lithium™ battery manage heat?

Our patented 56V ARC Lithium™ technology is designed like no other battery.

Our unique battery maximises cooling in three ways:

1

MECHANICALLY

2

CHEMICALLY

3

ELECTRONICALLY

1

How we manage heat **mechanically**

Rather than conventional "brick shaped" batteries where the cells are packed together, overheat and shut down, our unique Arc design maximises surface area and so dissipates heat more effectively.

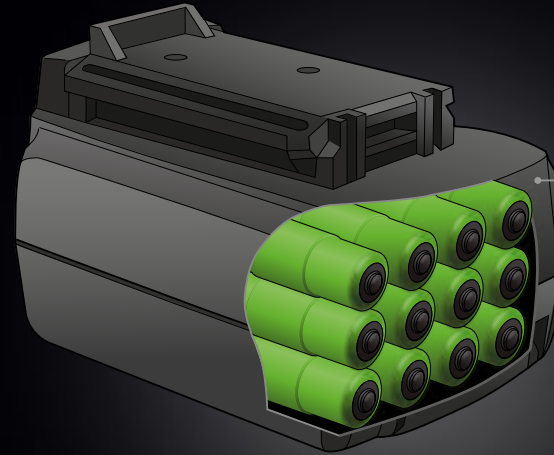

BRICK SHAPE BATTERY



UNIQUE ARC SHAPE BATTERY

Benefits of Arc design

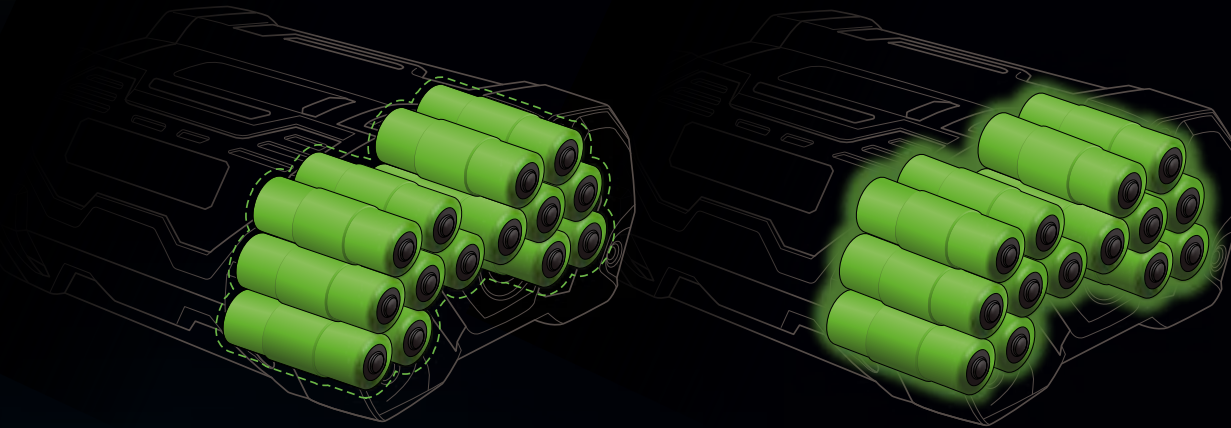

INCREASED SURFACE AREA

More surface area = more heat transferred to atmosphere.

CELLS CLOSE TO SURFACE

All cells are as close to the surface as possible meaning that there is more air passing over each cell.

Exterior mounted

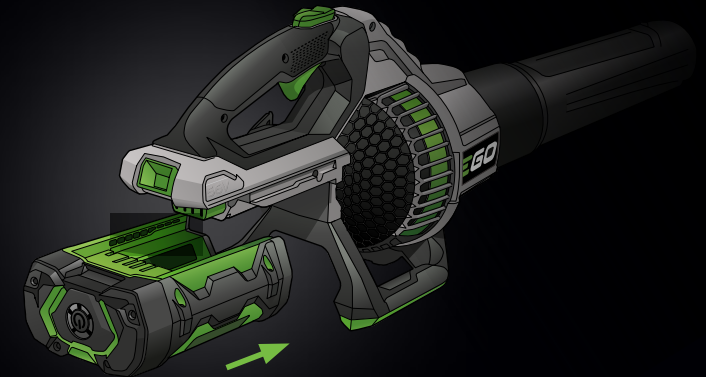

EXTERIOR MOUNTED

Unlike other manufacturers, our batteries fit onto the outside of our tools, and are not encased on the inside which means they stay cool to deliver longer lasting power.

2

How we manage heat **chemically**

Actively absorbing heat with **Keep Cool™ Technology**

Each and every cell is surrounded by our unique Keep Cool™ phase change material (PCM) that absorbs heat energy and keeps individual cells at their optimum temperature for longer, while increasing battery life.

KeepCool™ Technology is featured in 1P and 2P EGO battery products: this includes BA1400, BA1400T, BA2800, BA2800T and BA2242T. For EGO batteries that contain more cells (3P and 4P batteries), the operating load is spread more, so there is no need to include the KeepCool™ phase change material layer.

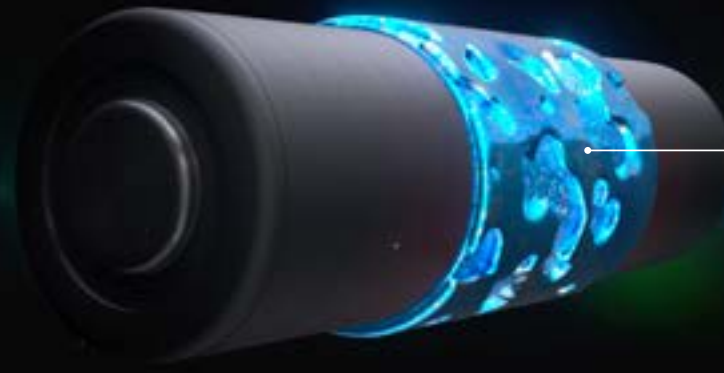

KEEP COOL™
phase change material
surrounds each cell

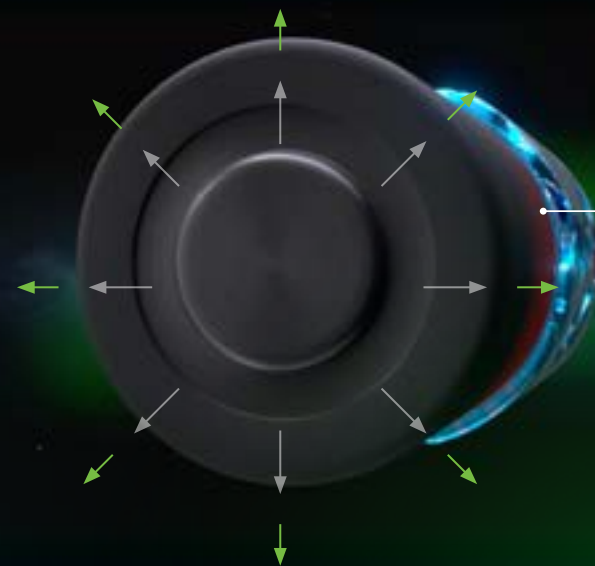

ABSORBS HEAT ENERGY
to keep cells at their optimum
temperature for longer

Phase change material (Keep Cool™ Technology)

How the phase change material (PCM) works in our batteries:

When a material goes from a high energy state to a low energy state, it releases energy. For example, liquid water loses energy when it becomes solid ice. And the reverse is true – solid ice gains energy to become liquid water.

When a material is changing state from solid to liquid, the energy applied goes towards changing the state of the material, rather than heating up the battery cell.

That's how our PCMs work.

Our PCM begins absorbing heat as a solid. However, unlike traditional heat storage materials, when the PCM reaches its melting temperature, it absorbs large amounts of energy at an almost constant temperature until all the material is transformed into liquid.

The more heat the PCM absorbs from the battery, the more heat the battery can generate without overheating. This helps to maximise run time.

When the battery is not in use, the PCM cools down by safely transferring heat to the atmosphere and turning back into a solid.

25A Discharging compared with EGO battery without phase change material

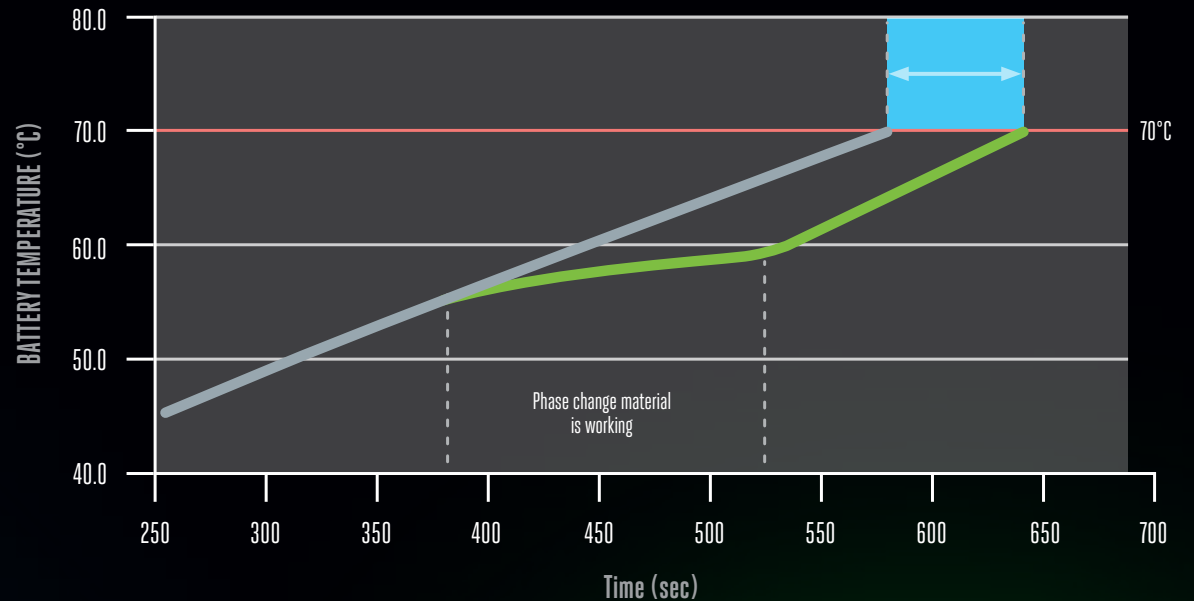

KEY:

- Without phase change material
- With phase change material
- Maximum temperature reached, battery shut down
- Phase change material helps to extend 65 seconds longer runtime before 70°C, provides 444Ah (11%) more capacity

3

How we manage heat **electronically**

Individually monitoring each cell

Most competitor battery packs have one or two sensors to monitor the battery's temperature. Normally they're located on the cells that are most likely to be hottest and some have even been known to locate them by the coolest cells. But cells can change after several charge cycles. This means the sensors may not be monitoring the hottest cells anymore.

That's why we decided one or two sensors just wasn't enough.

For example, we engineered 28 sensors to monitor the temperature of all cells (on our 2P battery). The sensors are controlled via the EGO Battery Management System (see "How does EGO ensure the most versatile performance?" on page 34 for more information).

Ensuring safety prolongs the battery lifetime

If there are only one or two cells being monitored within a battery pack, it is possible that the hottest cell is not immediately identified. If the battery safety system does not shut down the battery pack when an individual cell is overheating it could become damaged beyond repair rendering the entire pack useless. This could also represent a potential safety hazard.

In EGO batteries, because every cell is monitored, when a specific overheating cell is identified, the entire battery will shut down until it cools down to within the optimum operating parameters. This ensures safe use and provides extended battery life.

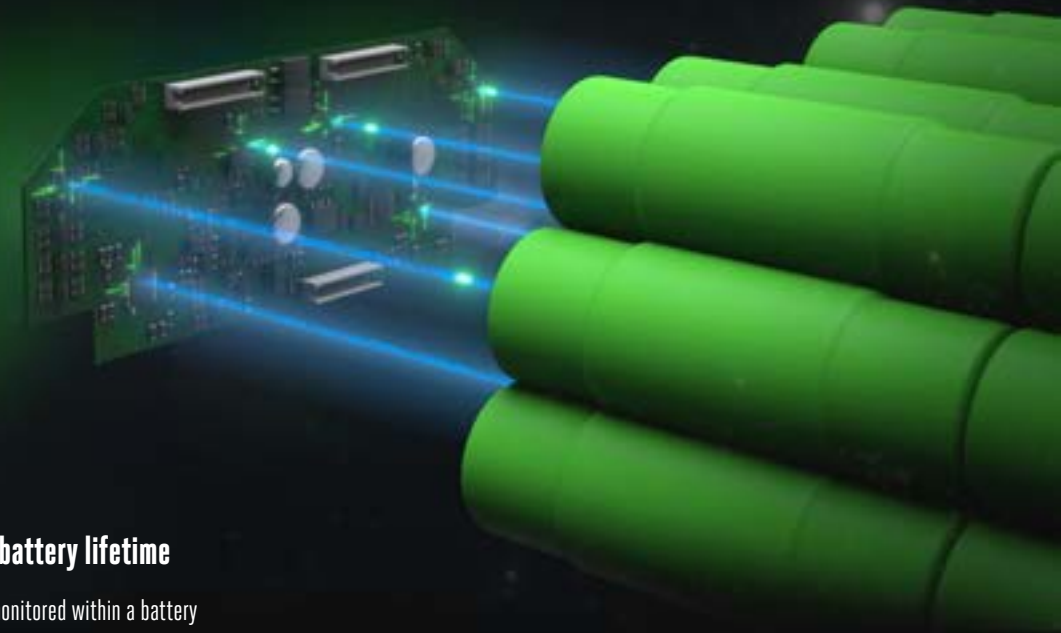

WHY EGO 56V?

The ultimate in versatile power

31

Should I use a smaller voltage battery for less demanding work?

33

EGO 56V is the ultimate in versatile power

EGO 56V. Delivers unmatched versatility and performance, providing the right power for every task.

An 80V or 36V system cannot achieve the same versatile power as EGO's 56V system. EGO delivers the optimal power for any task*.

No hand-held battery has
**MORE VERSATILE
POWER!***

BATTERY LAYOUT	1P	2P	3P	4P
DISCHARGING CURRENT	20A**	40A**	60A**	80A**
36V - 40V	800W	1600W	2400W	3200W
50.4V - 56V	1120W	2240W	3360W	4480W
72V - 80V	1600W	3200W	n/a An 80V 3P or 4P battery would be too big and heavy for comfortable use	

THE MOST VERSATILE POWER OF ANY HAND-HELD BATTERY

See page 40 to see how any EGO 56V ARC Lithium™ battery fits any tool in the 100+ EGO Power range.

**Rated continuous discharging current of 2.0Ah cell

Should I use a smaller voltage than 56V for less demanding tasks?

No.

EGO's 56V range of batteries are designed to give the optimal amount of power across the widest range of tools and tasks.

The **seven** batteries in our range cover all applications, from leaf blowing in small spaces to heavy duty cutting.

All the batteries are 56V. Only the capacity (Ah) and weight differ - tailored to provide the right amount of power and run time for each battery's intended applications.

This contrasts with competitor batteries, which are either underpowered or overpowered for certain tasks (see table on next page).



BA1400T
2.5AH BATTERY 140WH, 1P



BA2242T
4AH BATTERY 224WH, 2P



BA2800T
5AH BATTERY 280WH, 2P



BA3360T
6AH BATTERY 336WH, 3P



BA4200T
7.5AH BATTERY 420WH, 3P



BA5600T
10AH BATTERY 560WH, 4P



BA6720T
12AH BATTERY 672WH, 4P

How EGO 56V provides greatest coverage across the whole range of cordless outdoor equipment

EGO 56V. For maximum coverage across the whole range of battery-powered outdoor power equipment.

Only EGO 56V can supply the optimum power for the widest range of demanding commercial tasks.

Even the largest 80V batteries are underpowered at the top range (and overpowered for pretty much everything else).

EGO's smaller 56V batteries are perfectly configured to get the job done without sacrificing power – or being lumbered with excess weight.

With a choice of seven batteries, the 56V system gives more flexibility and choice of battery weight and cost*, compared to the limited choice for 80V and 40V. And for tools that draw power in excess of 3500W, an 80V 2P battery would be insufficient too.

*See page 58 for more information on cost comparisons.

**EGO PeakPower Technology and combination of multiple EGO 56V batteries required.

Comparative power required for different tools and tasks

	DOMESTIC GARDENS	LARGE GARDENS & PROFESSIONAL	PROFESSIONAL GROUNDS MAINTENANCE
LAWN MOWERS	1.0kW - 2.0kW	2.0kW - 2.5kW	2.5kW - 3.0kW
BLOWERS	0.4kW - 1.2kW	1.2kW - 1.4kW	1.4kW - 1.6kW
BACKPACK BLOWERS	1.2kW - 1.5kW	1.5kW - 1.8kW	1.8kW - 2.2kW
HEDGE TRIMMERS	0.4kW - 0.7kW	0.7kW - 0.9kW	0.9kW - 1.0kW
BRUSH CUTTERS	0.5kW - 0.8kW	0.8kW - 1.0kW	1.0kW - 1.2kW
LINE TRIMMERS	0.45kW - 0.85kW	0.8kW - 1.0kW	1.0kW - 1.2kW
CHAINSAWS	1.0kW - 1.5kW	1.5kW - 2.0kW	2.0kW - 3.0kW
RIDE-ON MOWERS	3.0kW - 10.0kW**	8.0kW - 20.0kW**	18.0kW - 35.0kW**

650W 800W 1200W 2400W 3600W

Suitability of battery voltage for task

40V	GOOD	NOT SUITED
EGO 56V	OPTIMAL	
80V	NOT SUITED	GOOD

EGO 56V. The right battery choice for any task

**THE MOST
VERSATILE
PERFORMANCE
FOR ANY TASK**

**THE MOST
VERSATILE
POWER-TO-
WEIGHT RATIO**

**THE MOST
VERSATILE
PHYSICAL
SIZE**

**THE MOST
COST-EFFECTIVE*
BATTERY
PLATFORM**

*See page 58 for cost comparisons

CHOOSING THE RIGHT BATTERY FOR THE JOB

Which battery should I use?	37
Are EGO batteries compatible with every device?	39
Are some tools designed to use more than one EGO battery?	41
Are EGO batteries effective when used with EGO professional tools?	42
EGO vs competitors	44

Which battery should I use?

When choosing which battery to use on your EGO tool, there's really only two things you need to consider:

1. How much power do you need for the tool?
2. How long the power will last
3. How much weight will the battery add to the balance and feel of the tool?

From the lightest 2.5Ah to the high density 12Ah battery with the longest run time, we have the right battery for every task. And whatever size you choose, they all feature our innovative 56V ARC Lithium™ technology. Plus, all our batteries fit all our tools.* So whichever you choose, simply click in and get to work.

*For portable handheld batteries.
EGO Robotic Mowers and 12V Shrub Shears are not compatible with ARC Lithium™ 56V battery system.

			
2.5AH	4AH	5AH	6AH
Blower Hedge Trimmer Line Trimmer Multi-tool	Chainsaw Line Trimmer Blower Lawn Mower Hedge Trimmer	Blower Lawn Mower Line Trimmer Multi-tool Chainsaw	Backpack Blower Lawn Mower Brush Cutter Chainsaw
			
7.5AH	10AH	12AH	
Backpack Blower Lawn Mower Brush Cutter Chainsaw	Lawn Mower Ride-on Mower Snow Throwers Backpack Blower	Lawn Mower Ride-on Mower Snow Throwers Backpack Blower	

The EGO Backpack Harness

Compatible with every tool, including our new commercial range, our new harness and adapter means any EGO Power+ battery can be used to power all our tools

Power and comfort, combined

Light, comfortable and ergonomic, the EGO Power+ Pro X backpack harness is the most comfortable way to enjoy the industry-leading power. It works with all our batteries and by carrying the battery in the backpack instead of the tool it makes the tool lighter, more maneuverable and more comfortable to use, especially over prolonged periods.



Are EGO batteries compatible with every device?

YES.

Whichever EGO Power⁺ 56V ARC Lithium™ portable battery you choose for the job, our clever design means it will fit any tool* in the power⁺ range and when it's time to top up your power, your charger will fit any battery.

*For portable handheld batteries.

EGO Robotic Mowers and 12V Shrub Shears are not compatible with ARC Lithium™ 56V battery system.

ANY BATTERY, MORE THAN 100 TOOLS

Our industry-leading 56V ARC Lithium™ batteries work with all EGO Power+ tools*, even our Pro X range. With great performance and long run times, simply select your tool, click in and go.

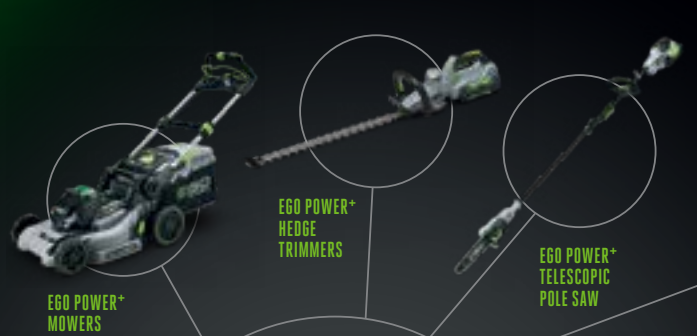

EGO POWER+
MOWERS

EGO POWER+
HEDGE
TRIMMERS

EGO POWER+
TELESCOPIC
POLE SAW



EGO POWER+
RIDE-ON MOWERS



EGO POWER+
BLOWERS & VAC



EGO POWER+
SNOW THROWERS



EGO POWER+
PRESSURE WASHER



EGO POWER+
LIFESTYLE



EGO POWER+
LINE TRIMMERS
& BRUSH CUTTERS



EGO POWER+
CHAINSAWS

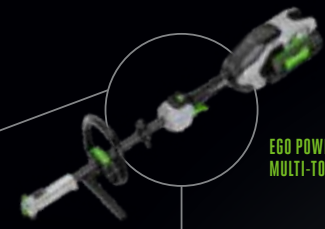

EGO POWER+
MULTI-TOOL



HEDGE TRIMMERS POLE SAW LINE TRIMMERS BRUSH CUTTER ROTOCUT EDGER
CULTIVATOR BRUSHES OLIVE SHAKER SNOW SHOVEL DETHATCHER



EGO POWER+ PRO X LAWNMOWER EGO POWER+ PRO X BLOWERS EGO POWER+ PRO X HEDGE TRIMMERS EGO POWER+ PRO X TELESCOPIC POLE SYSTEM PRUNING SAW HEDGE TRIMMER
EGO POWER+ PRO X LINE TRIMMERS BRUSH CUTTER ROTOCUT EGO POWER+ PRO X REAR HANDLE CHAINSAW EGO POWER+ PRO X TOP HANDLE CHAINSAW EGO POWER+ PRO X MULTI-TOOL POWER HEAD

*For portable handheld batteries.
EGO Robotic Mowers and 12V Shrub Shears are not compatible with ARC Lithium™ 56V battery system.

Are some tools designed to use more than one EGO battery?

Yes.

Certain EGO tools are designed to use multiple batteries, intelligently combining the power of dual batteries, or up to six batteries, to deliver optimal power across the discharge cycle.

Peak Power™ Technology

EGO's innovative proactive power output management system, Peak Power™ senses how many batteries are connected to the system, then regulates the output power automatically.

When multiple fully-charged batteries are in use, the power unit will output the maximum power continuously, meaning all batteries will deplete in power at the same rate.

When fully-charged, and partially-charged batteries are used in combination, the system can detect this and will automatically discharge the fully-charged battery first, until the power matches that of the remaining batteries. Once all are at the same power level, the system will change the power output to deplete simultaneously. This ensures that power is delivered in the most efficient and effective way for the task in hand.

PEAK™
POWER 
TECHNOLOGY



How Peak Power™ optimises power over time for a dual-battery machine:

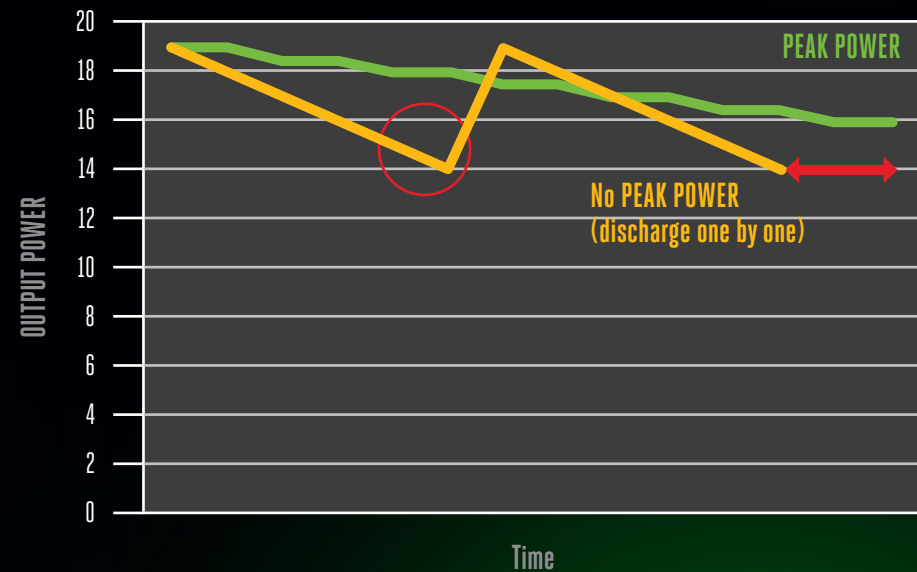

Are EGO batteries effective when used with EGO Professional tools?

YES - THEY OFFER THE ULTIMATE IN FLEXIBILITY

The EGO Pro X range redefines professional battery powered tools, delivering maximum flexibility and choice. So that professionals can choose to work in the best way to suit the job - every Pro X tool is compatible with all EGO battery options*, offering ultimate efficiency to complete any job of any size. The EGO Pro X Backpack Harness can be used to redistribute the weight of the battery when required, and the EGO Pro X Backpack battery can be used for tasks that require a longer run time.



EGO POWER+ PRO X BACKPACK BATTERY 1568WH

EGO POWER+ PRO X BACKPACK HARNESS

EGO POWER+ PRO X BATTERY HOLSTER

EGO POWER+ PRO X MULTI-TOOL POWER HEAD
x15 POWERS ALL 15 EGO MULTI-TOOL ATTACHMENTS

EGO POWER+ PRO X BACKPACK BLOWERS

EGO POWER+ PRO X BLOWERS

EGO POWER+ PRO X HEDGE TRIMMERS

EGO POWER+ PRO X TOP HANDLE CHAINSAW

EGO POWER+ PRO X LAWNMOWER

EGO POWER+ PRO X LINE TRIMMERS/BRUSH CUTTERS
BRUSH CUTTER ROTOCUT ELASTOBLADE

EGO POWER+ PRO X TELESCOPIC POLE
PRUNING SAW HEDGE TRIMMER

EGO POWER+ PRO X REAR HANDLE CHAINSAW

*For best working efficiency, the EGO Pro X Lawnmower and EGO Pro X Backpack Blower are not compatible with the EGO Backpack Battery, EGO Backpack Harness or EGO Battery Holster.

EGO VS COMPETITORS



1 BATTERY AND 1 CHARGER
FOR MULTIPLE TOOLS



ARC
LITHIUM
56V

700W RAPID CHARGER

For large gardens and professional use

COMPETITOR 1

2 DIFFERENT BATTERIES AND CHARGERS
FOR 2 DIFFERENT RANGES OF TOOLS



SYSTEM 1

For medium gardens



SYSTEM 2

For large gardens and professional use

COMPETITOR 2

2 DIFFERENT BATTERIES AND CHARGERS
FOR 2 DIFFERENT 36 VOLT RANGES OF TOOLS.

There is some partial overlap in systems between chargers.



SYSTEM 1

For medium gardens



SYSTEM 2

For large gardens and professional use

EGO vs THE COMPETITION

What makes EGO the best?	46
Do EGO batteries have more usable power than competitors?	48
Are there any other battery technologies out there?	50

What makes EGO the best?

EGO is the only manufacturer of battery powered outdoor power equipment that delivers the power of petrol while optimising run time, weight, size and cost.

The perfect **balance.**

EGO batteries perform during the toughest applications without sacrificing ease of use.



COST



WEIGHT



SIZE



PERFORMANCE

**Do EGO batteries have
more usable power than
competitors?**

YES.

The EGO Power+ 56V ARC Lithium™ battery has the most usable power of any hand-held battery on the market.

Are there other battery technologies out there?

EGO will continue to deliver innovation in new product development – and clean, reliable power for a greener future.

We are continually exploring new technologies and developing these for the right applications in the world of battery-powered outdoor power equipment.

There are two technologies currently under development and evaluation by EGO's technical design and test teams. Pouch Cell and Tabless Cell battery technologies could potentially deliver further advancements in the delivery of efficient power from battery cells.

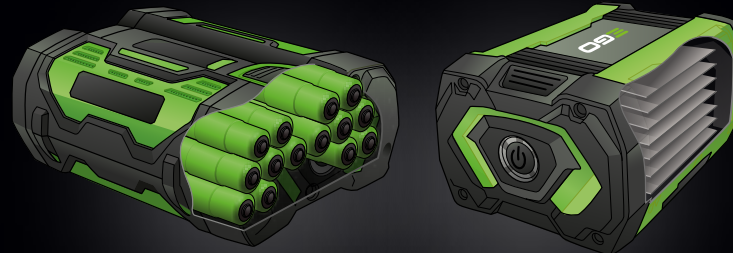

CYLINDRICAL CELLS

POUCH CELLS

Pouch Cell battery technology

In contrast to cylindrical lithium-ion battery cells, Pouch Cells are configured in a flat shape which creates less internal electrical resistance. Generation of less heat, creates the potential to provide more power, longer run times, longer battery lifespan and faster charging times. Pouch Cell batteries also have the potential to be smaller and lighter in weight.

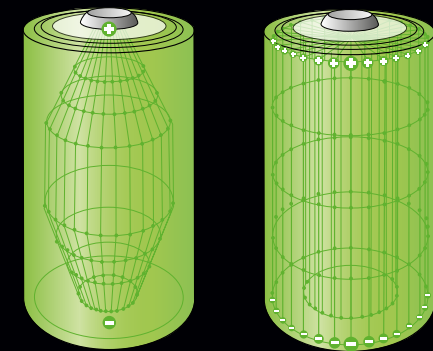

TAB DESIGN

TABLESS DESIGN

Tabless Cell battery technology

Whilst Tabless Cell technology does make use of cylindrical battery cells, the internal construction of the individual cells is different. Each cell contains a huge number of parallel pathways which create less internal electrical resistance and therefore less heat. This also creates the potential for more power, longer run times, longer battery lifespan and faster charging times.

What are the pros and cons of rapid chargers?

When it's time to recharge, the EGO Power+ rapid charger provides impressively fast charging times.

The intelligent battery control system constantly monitors each cell's charge and temperature to deliver the most efficient and quickest charge. Plus, the fan-cooling system allows the battery to start charging sooner and finish faster. As a result, the time it takes to recharge the battery is often less than the run time you get from a full charge. In fact, with the rapid charger, the 2.5Ah battery takes just 25 minutes. So with two batteries on the go, you'll have all the power you need, all day long.

Repeated use of the rapid charger can lead to some reduction in cycle life, but this is negligible for the average user. The standard EGO charger (CH2100E) will ensure maximum cycle life due to lower charging currents used.

For users of multiple batteries, the EGO Multi-port Charging Case can be used for rapid charging of up to six EGO 56V ARC Lithium™ batteries from one charger, combined with the EGO 1600W Charger.



RAPID CHARGER
(CH7000E-T)



STANDARD CHARGER
(CH2100E)



MULTI-PORT CHARGING CASE & 1600W CHARGER
(CHU600-K0004)

PERFORMANCE STATISTICS								
BATTERY MODEL	BA1400T	BA2240T	BA2800T	BA3360T	BA4200T	BA5600T	BA6720T	
CAPACITY (AH)	2.5Ah	4.0Ah	5.0Ah	6.0Ah	7.5Ah	10.0Ah	12.0Ah	
ENERGY (WH)	140WH	224	280WH	336WH	420WH	560WH	672WH	
CHARGE TIMES	RAPID CHARGER: CH7000E-T	30 mins	30 mins	40 mins	35 mins	60 mins	70 mins	75 mins
	STANDARD CHARGER: CH2100E	50 mins	80 mins	100 mins	120 mins	145 mins	190 mins	220 mins
	MULTI-PORT CHARGING CASE AND 1600W CHARGER	Approx. 60 minutes per 20Ah*						
WEIGHT	1.2kg	1.9kg	2.2kg	2.6kg	2.8kg	3.4kg	3.6kg	

*combination of batteries may affect charging time

For information on EGO's Pro X multi-battery charging system for professional users, please see pages 54-59

How many recharge cycles can be expected?

EGO batteries are capable of 800–1,000 cycles with 60% of their original capacity remaining.

When capacity decreases, only run time is affected. Battery power and safety remain constant. Unlike lead acid batteries, Lithium-ion batteries have no memory effect. Our batteries can be partially charged without damaging their capacity.

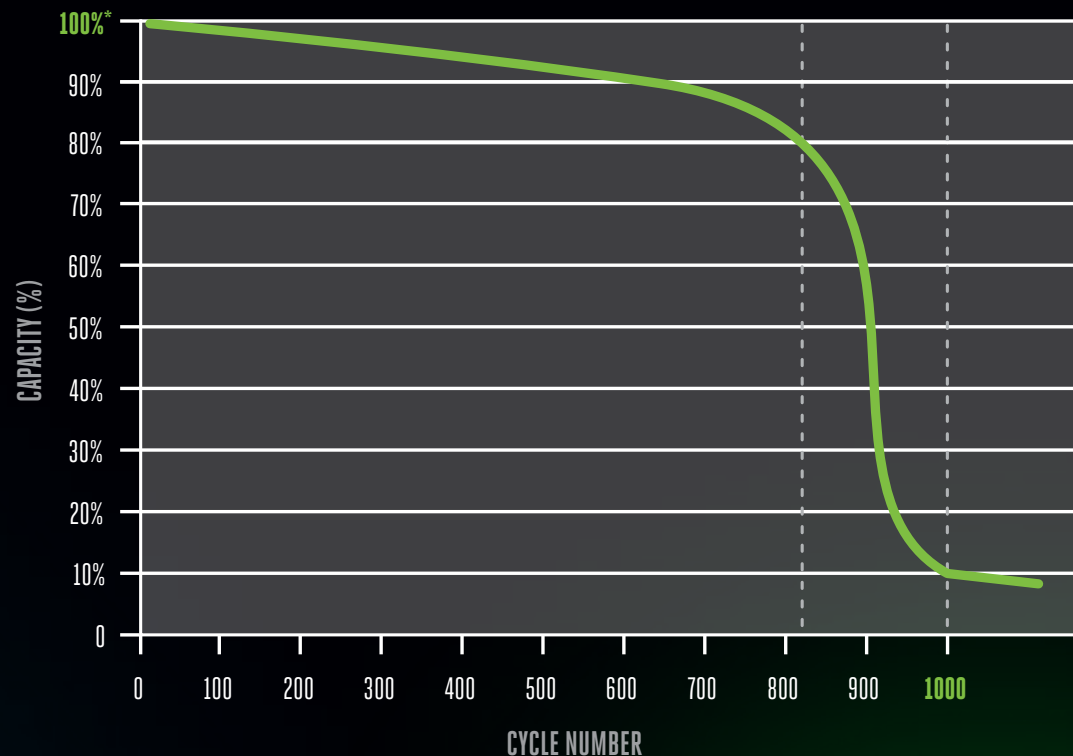

*For illustration only. Actual performance may be influenced by various external factors.

**How many batteries
can be charged from
a single charger?**

Up to 70 batteries can be charged from a single EGO Pro X Charging Hub

A breakthrough in all-day-long power

At the centre of the new EGO Pro X battery charging system is the EGO PGX Power Hub. More than 250Ah of energy can be charged in sequence overnight - ready for the next day's work.

The EGO Pro X Charging System can be extended as your needs grow, charging up to 70 batteries* from a single EGO 1600W PGX Charging Hub. Designed to connect with existing standard power outlets, so there's no need to update the power supply for installation.

EGO Pro X Charging System

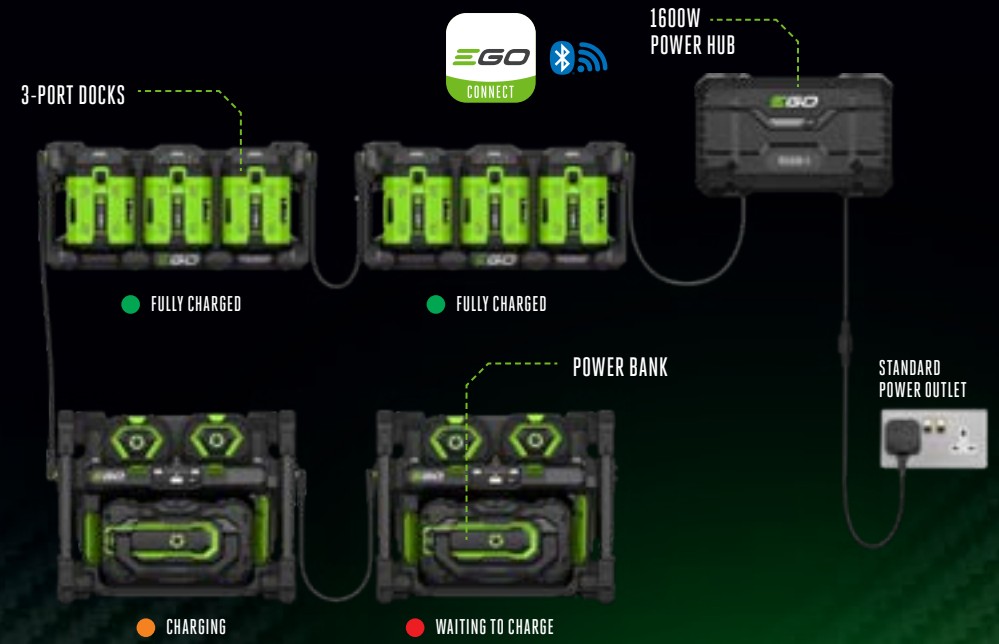

*Assumes a total of 60 x 2.5Ah EGO batteries charged over a period of 12 hours.

How does this compare to the competition?

A breakthrough in battery charging efficiency

The EGO Pro X charging system outperforms the competition, both in terms of how much capacity can be charged, and how many portable batteries can be charged, in a period of 12 hours.

BRAND	MODEL/SYSTEM	MAXIMUM POSSIBLE AC CHARGING PORTS	AH IN 12 HOURS	PORTABLE BATTERIES 12 HOURS	MAX kWh 12 HOURS
COMPETITOR 1	System 1	48	200Ah	28	8kWh
	PGX 1600W Hub	90	250Ah	60	14kWh
COMPETITOR 2	System 1	3	162Ah 150Ah (System 1) 12Ah (Portable Batteries)	3	8kWh
	System 2	8	184Ah 8* Batteries	8	12kWh
COMPETITOR 3	System 1	8	72Ah 8* Batteries	8	2.6kWh
	System 2	4	76Ah 4* Batteries	4	1.3kWh
	System 3	16	144Ah 16* Batteries	16	5.2kWh

Max claims for autonomous charging from a single power connection over 12 hours

Data is available to support the comparisons shown on this page

Can batteries be charged remotely on site?

YES - with EGO's super-fast, on-site portable battery charging system.

The EGO Pro X Power Bank is a breakthrough charging system for all-day battery power, reducing the need to carry more batteries. The system uses the energy from the EGO Professional 40Ah High Capacity Battery to charge any of EGO's portable ARC Lithium™ batteries, ensuring that run time anxiety is a thing of the past, taking all-day professional working to the next level.



EGO Pro X Power Bank



Can the charging & status of EGO batteries be controlled remotely?

YES - with the free, downloadable EGO Connect app.

EGO's Pro X Charging Hub and Power Bank are Wifi and Bluetooth enabled to connect with all enabled EGO batteries and tools. Charging and Status of batteries and tools can be controlled remotely using the EGO Connect App via smart phone and laptop devices.

EGO Connect functions:

- Monitor / view charging status and statistics
- Prioritise charging
- Charging completion reminder
- Battery optimisation
- Usage statistics
- Firmware upgrades



EGO Pro X Charging System with Wifi and Bluetooth™ connectivity

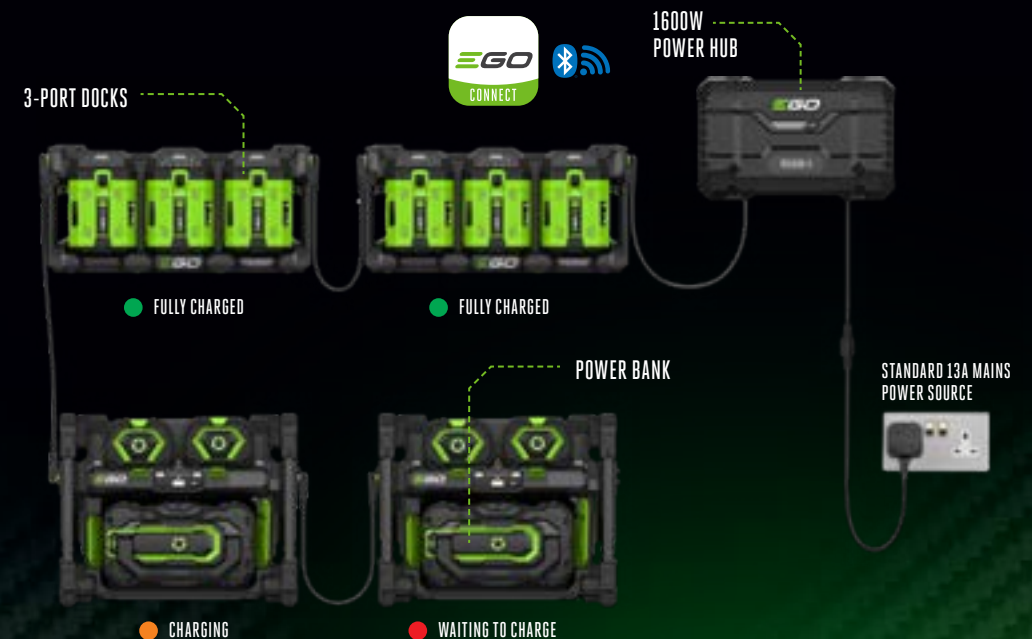

How cost effective and efficient is the EGO charging system?

There are many variables in professional charging systems that can be used for comparison, but there are some key advantages that EGO Pro X has over its competitors, no matter how the systems are compared.

The EGO Pro X advantages

- Up to **250Ah of energy can be charged in 12 hours** from a single standard power socket
- Lower initial **purchase price**
- **Easier to scale up** as business needs grow
- **More cost effective** - substantially lower cost per unit of energy charged



COMPETITOR 1

COMPETITOR 2

Component	Quantity	Capacity / Price / Cycle	Capacity Charged in 12h	Daily Wh	MRSP €	Year 1 €/kWh	Portable Battery Cycles	Warranty
	x 1	250Ah	162Ah	14,000	€ 14,184	€ 4.02	5 PER DAY	2 years BATTERY
	x 1	250Ah	162Ah	14,000	€ 14,184	€ 4.02	5 PER DAY	2 years BATTERY
	x 1	PGX1600H	162Ah	14,000	€ 14,184	€ 4.02	5 PER DAY	2 years BATTERY
	x 1	PGX1600H	162Ah	14,000	€ 14,184	€ 4.02	5 PER DAY	2 years BATTERY
	x 5	PGX1400PB HC2240T	162Ah	14,000	€ 14,184	€ 4.02	1,260 PER YEAR*	5(+3) years 2000(+1000) cycles
	x 5	PGX1400PB HC2240T	162Ah	14,000	€ 14,184	€ 4.02	1,260 PER YEAR*	5(+3) years 2000(+1000) cycles
	x 10	BA2800T	162Ah	14,000	€ 14,184	€ 4.02	2,052 PER YEAR*	5(+3) years 2000(+1000) cycles
	x 1	250Ah	162Ah	14,692	€ 26,844	€ 7.25	7 PER DAY	2 years BATTERY
	x 8	250Ah	162Ah	14,692	€ 26,844	€ 7.25	7 PER DAY	2 years BATTERY
	x 1	CHARGER	162Ah	14,692	€ 26,844	€ 7.25	7 PER DAY	2 years BATTERY
	x 1	CHARGER	162Ah	14,692	€ 26,844	€ 7.25	7 PER DAY	2 years BATTERY
	x 6	CHARGER	162Ah	14,692	€ 26,844	€ 7.25	7 PER DAY	2 years BATTERY
	x 2	CHARGING STATION	162Ah	14,692	€ 26,844	€ 7.25	7 PER DAY	2 years BATTERY
	x 2	CHARGING STATION	162Ah	14,692	€ 26,844	€ 7.25	7 PER DAY	2 years BATTERY
	x 4	BATTERY	162Ah	14,692	€ 26,844	€ 7.25	7 PER DAY	2 years BATTERY
	x 4	BATTERY	162Ah	14,692	€ 26,844	€ 7.25	7 PER DAY	2 years BATTERY
	x 8	BATTERY	162Ah	14,692	€ 26,844	€ 7.25	7 PER DAY	2 years BATTERY
	x 8	BATTERY	162Ah	14,692	€ 26,844	€ 7.25	7 PER DAY	2 years BATTERY

*Assumes 252 working days per year

Data is available to support the comparisons shown on this page

LOOKING AFTER YOUR BATTERIES

How should batteries be stored?	61
How should batteries be transported?	62
Are EGO batteries weather resistant?	63
What should be done with wet batteries?	64
What is the shelf life of a typical battery?	65
What is the warranty period and what should I do if my battery is faulty?	66
How should EGO batteries be recycled?	67

How should batteries be stored?

Maintaining a full charge over time without using the battery can damage cells. According to the characteristics of Lithium-ion cells, when they are stored at full capacity over a long period of time without use, the recoverable capacity will be reduced.

EGO batteries discharge automatically after 30 days without use to reach the optimum storage capacity of 30%.

- No special temperature requirements **for winter**
- No need to recharge **during storage**
- Batteries can be **left in the charger**
- Batteries can be used at **any state of charge**
- Batteries should be **stored dry**

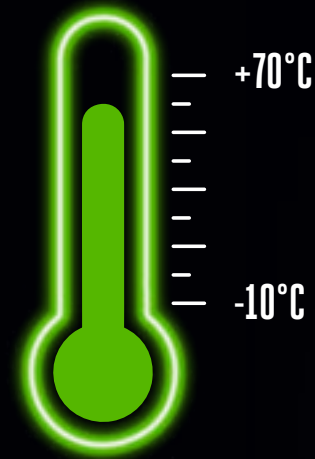

-10 to +70°C

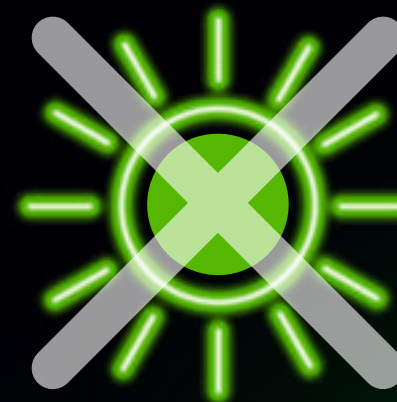

BATTERIES SHOULD NOT BE STORED IN DIRECT SUNLIGHT

(dry/indoors/warm)

How should batteries be transported?

To keep our batteries safe and sound, the electronics are already protected from dust and moisture by a resin coating and the cells are packaged in a robust case that absorbs shocks and vibrations.

However, when transporting batteries, always ensure they are well secured against movement and the terminals are protected from short circuiting.

For commercial users, simplified or full ADR (a treaty governing transport of hazardous materials by road) rules apply. For advice, contact your local dealer or EGO directly.



TRANSPORTATION BOX
that can carry up to
5 EGO batteries of any size

BBOX2550



MULTI-PORT CHARGING CASE
for charging and transporting up to
6 EGO batteries of any size

CHU6000

Are EGO batteries weather resistant?

Yes.

All EGO batteries are **IPX4** rated when connected to the tool.

This means they have been proven to be safe for use after splashing with water (equivalent to light rain).

About IPX rating

The International Protection Marking (IPX) classifies the degree of protection provided against water ingress and other materials. It is published by the International Electrotechnical Commission (IEC).

Note: the BAX1500 backpack battery has a rating of IP56



IPX4 TEST

Splashing of water

Water splashing against the enclosure from any direction shall have no harmful effect, utilizing either: 'A' an oscillating fixture, or 'B' A spray nozzle with no shield.

Test 'A' is conducted for 10 minutes.
Test 'B' is conducted (without shield) for 5 minutes minimum.

Oscillating tube: Test duration: 10 minutes, or spray nozzle (same as IPX3 spray nozzle with the shield removed)

Source: https://en.wikipedia.org/wiki/IP_Code

What should be done with wet batteries?

Batteries that have been exposed to water for longer than recommended should be returned to EGO dealers for inspection.

CAUTION:

Batteries should only be assessed by trained personnel.



What is the shelf life of a typical battery?

Due to their high capacity, all EGO batteries can be stored unattended for a minimum of 10 years without damaging capacity and cycle performance

After 30 days batteries discharge to 30% capacity (to ensure longevity)

2.0Ah battery example:

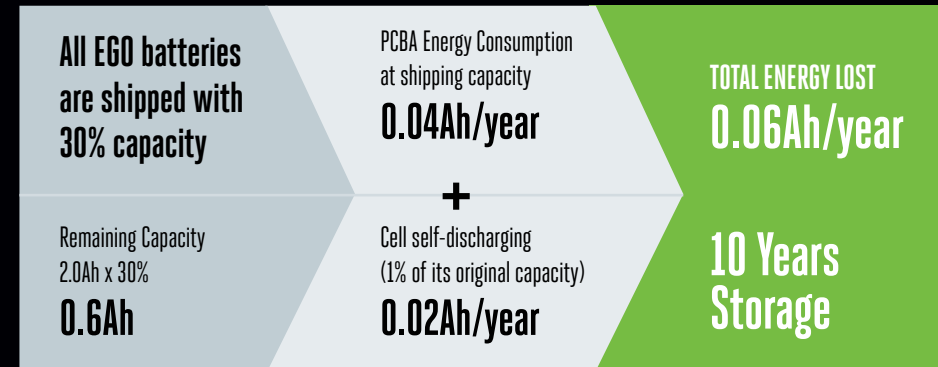









ORIGINAL CAPACITY (Ah)	YEARS OF UNATTENDED STORAGE BEFORE OVER-DISCHARGED
2.5	10
4.0	16
5.0	17
6.0	18
7.5	20
10.0	40
12.0	23

What is the warranty period and what should I do if my battery is faulty?

Batteries have a two year warranty, extended by one year if users register their battery. The warranty for commercial users is 2 years (1 year + 1 year for registration of tool).

Faulty batteries should be returned to where they were purchased.

TOOLS	BATTERIES	
	DOMESTIC USE	PROFESSIONAL USE
 <p>FOR DOMESTIC, SMALL TO MEDIUM SIZED GARDENS</p>		N/A
 <p>FOR LARGE GARDENS AND PROFESSIONAL USE</p>		
 <p>FOR USE BY PROFESSIONALS AND SPECIALISTS</p>		

Note: Warranties shown are for EGO portable hand-held batteries.

How should EGO batteries be recycled?

EGO place the utmost importance on respecting the environment and comply with all necessary recycling standards.

Our batteries have a long lifespan, but when the time comes, simply return them to where they were purchased to ensure they are safely recycled in accordance with local and international regulations.

The country importer of the batteries is responsible for ensuring that batteries which have reached the end of their life, are returned and recycled. The importer in each country is committed to be part of their countrywide, national scheme.

For further information, please follow the links on this page and the following pages for each country:

EGO Germany

Contracted with GRS SERVICE GmbH (Gemeinsames Rücknahmesystem Servicegesellschaft), for return and recycling of batteries:

[GRS Service](#)

EGO Austria

Regime information being updated

EGO Switzerland

Regime information being updated

EGO Denmark

Regime information being updated

EGO Sweden

Flex Scand and Bauhaus are members of EL-KRETSEN for battery recycling:

[El-kretsen](#)

EGO Norway

Regime information being updated

EGO Finland

Importer(Hautala Service) is contracted with ELKER / SELT Ry for battery recycling:

[Elker](#)

[Elker - free return](#)

CONTINUED...

EGO France

Contracted with ECOLOGIC for collection and recycling of batteries:

[Ecologic](#)

EGO Netherlands

Battery recycling was in partnership with STIBAT in 2023. From 2024, STIBAT merged with the OPEN FOUNDATION:

[Open Foundation](#)

EGO Belgium

Battery recycling is carried out in partnership with BEBAT:

[Bebat](#)

EGO Italy

Contracted with APIRAEE CONSORTIUM for collection and recycling of batteries:

[Apirae Consortium](#)

EGO UK

Partnered with BATTERYBACK PLC

Approval number: BCS2010864/E

BatteryBack provide a national battery recycling and compliance scheme across the UK:

[Batteryback](#)

EGO Republic of Ireland

Regime information being updated

EGO Iceland

Regime information being updated

EGO Greece

Regime information being updated

EGO Cyprus

Regime information being updated

EGO Latvia/Lithuania

Contracted with local companies, who are responsible for national battery collection and recycling.

[Gia](#)

[Zalvaris](#)

EGO Estonia

Registered with national battery recycling scheme (monitored by MTÜ EES-RINGLUS).

[Ees-ringlus](#)

EGO Poland

Consumers have a legal obligation to take their used batteries to designated separate collection points, retailers, locations designated by local governments, or companies specialising in the recycling and disposal of batteries:

[EGO dealers in Poland](#)

EGO Hungary

Batteries are retained by MP Motor Kft for 2-3 years, and then contracted for collection and disposal.

EGO Bulgaria

In partnership with BATTERY NORD RECYCLING. Report monthly on the import of batteries by kilogram and pay a fee for recycling of batteries:

[Nordrecycling](#)

CONTINUED...

EGO Romania

Contracted with RLG REBAT ROMANIA SRL - authorised and obliged to collect and recycle batteries:

[Rlg_rebat_romania](#)

EGO Czech Republic

Registered with battery collection, sorting and recycling system. Network operator is ECOBAT s.r.o.

[Ecobat](#)

Battery recycling facilities are in Belgium and France.

EGO Croatia

Regulated under the WASTE ACT and REGULATION on WASTE BATTERIES and ACCUMULATORS for collection and recycling of batteries:

[Disposal guidelines](#)

EGO Serbia

Contracted with SERBIA ECOLOGY for collection and recycling of batteries:

[Ekologija.gov.rs](#)

EGO Slovakia

Registered with:

[isoh.gov.sk](#)

Certified by NATUR PACK

Certification number: 10605

EGO Spain

Contracted with SUMABAT for battery collection and recycling:

[Sumabat](#)

EGO Portugal

Contracted with ELECTRAO for battery collection and recycling:

[Electrao](#)

[Ondereciclar](#)

EGO Turkey

Working with MAPAS for battery collection and recycling:

[Mapas](#)

EGO Israel

Regime information being updated

EGO Saudi Arabia

Regime information being updated

EGO Kuwait

Regime information being updated

EGO Bosnia Herzegovina

Governed by law on WASTE MANAGEMENT for collection and recycling of batteries:

EGO Slovenia

Part of national scheme, obligated to report sales of batteries and electric/battery powered products.

Paying E-WASTE TAX of 0,6 eur per 1 kg (600 eur per 1 tone) to cover the cost of battery collection from E-WASTE disposal points and recycling.

EGO Macedonia

Governed by law on WASTE MANAGEMENT for collection and recycling of batteries:

What do you get with an EGO battery?

56V ARC LITHIUM™ TECHNOLOGY

1 battery and 1 charger fits all tools**

The most versatile power and
performance for any task

Long run times

HEAT MANAGEMENT

Unique ARC shape

Exterior mounted

Phase change material – Keep Cool Technology™

High quality cells

Intelligent battery management system

DURABILITY & STRENGTH

Shock proof

IPX4 waterproof

VERSATILE POWER, PERFORMANCE & RUN TIME

Best value per Wh of any portable
hand-held battery

PORTABLE, REMOTE CHARGING SYSTEM

Super-fast on-site charging*

MULTIPLE BATTERY CHARGING SYSTEM

Charge up to 70 batteries overnight*

*These EGO Pro X charging systems can be purchased separately as optional add-ons for the professional user.

**For portable handheld batteries.

EGO Robotic Mowers and 12V Shrub Shears are not compatible with ARC Lithium™ 56V battery system.



POWER BEYOND BELIEF™

www.egopowerplus.com



All rights reserved. Neither this catalogue nor its text, images, illustrations or part thereof, may be reproduced, stored in a retrieval system, photocopied, recorded or transmitted in any form, whether electronic or otherwise, without our consent. To the best of our knowledge, as of September 2024, all descriptions, images and illustrations contained in this catalogue are correct at the time of going to print. We cannot, however, be held liable for any inaccuracies of description, image or illustration and reserve the right to change specifications without notification.

©EGO 2024